

HEAVY DUTY JACKING BEAM FL-2

AIR HYDRAULIC TWIN RAM JACKING BEAM

Item number: FL-2

- ✓ 2 individually controlled rams offer safe and balanced lifting
- ✓ Transversely sliding rams
- ✓ Can be made to fit all lifts due to its adjustable frame
- ✓ Frame height is adjusted and set to the customers individual specifications
- ✓ Supplied with 2 x 100 mm extensions

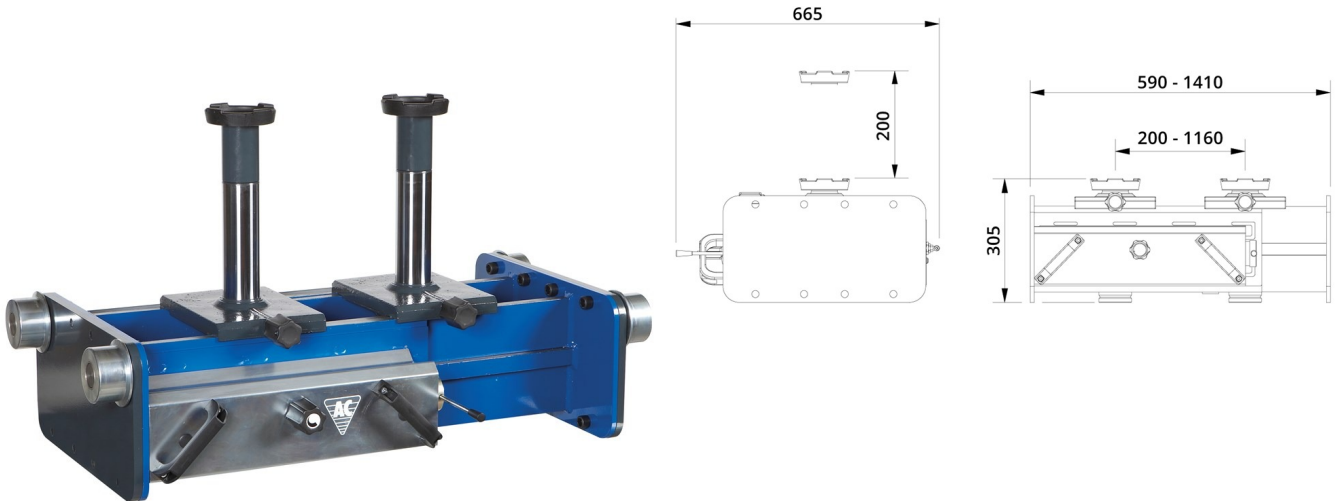

Capacity:	6 - 20 t
Stroke:	200 mm
Min height:	305 mm
Max height:	505 mm
Depth:	665 mm
Cylinder diameter:	60 mm
Air supply:	8 - 10 bar
Air consumption:	- 350 l/min
Weight:	202 kg

HEAVY DUTY JACKING BEAM

ACCESSORIES FL-2:

T4-2
Cross beam adaptor



Item number: 5866600

T5-2
Flexible and adjustable cross beam adaptor



Item number: 5866800

T6-2
Innovative cross beam adaptor



Item number: 5866055

LB
Diff beam

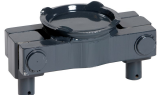

Item number: 9114300

FLTR
Trolley



Item number: 5836700

FW2-90
V-saddle



Item number: 9112700

FW2-130
V-saddle



Item number: 9112710

US-100
U-saddle



Item number: 9113210

HEAVY DUTY JACKING BEAM

ACCESSORIES FL-2:

US-130
U-saddle



Item number: 9113240

FG100
Extension



Item number: 9114100

FG200
Extension



Item number: 9114200

VB1
Wall bracket



Item number: 5866340

VB2
Wall bracket



Item number: 5866380

HSD-F
Front air connection kit



Item number: 5863410