

PIT JACK GDT

TELESCOPIC AIR HYDRAULIC PIT JACK

Item number: GDT

- ✓ Lowered design doubles usability compared to standard pit jacks
- ✓ Low construction height with a long stroke
- ✓ Rapid and precise air hydraulic unit with high speed ram travel
- ✓ Simple modern design with control panel at ergonomic working height

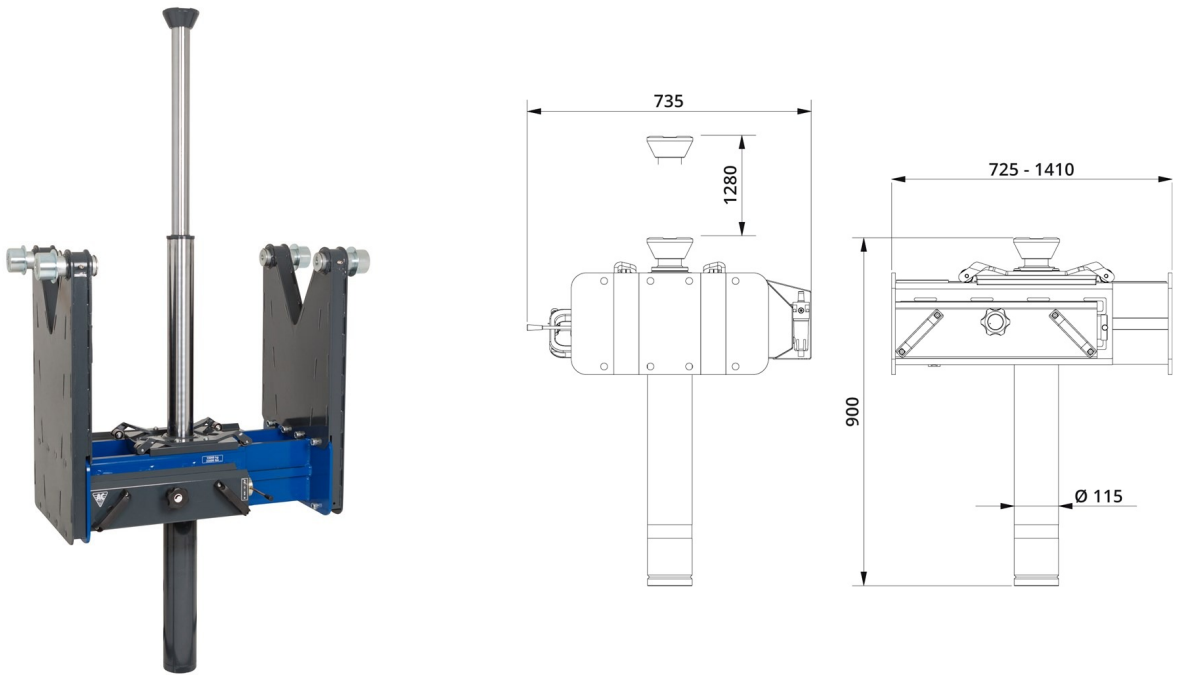

Capacity:	15 t
Stroke:	1280 mm
Min height:	900 mm
Max height:	2180 mm
Depth:	735 mm
Cylinder diameter:	60 mm
Air supply:	8 - 10 bar
Weight:	250 kg

PIT JACK

ACCESSORIES GDT:

AB
Support bridge



Item number: 5867010

ABT
Telescopic support bridge



Item number: 5867500

AS3
Gearbox saddle



Item number: 5900500

T4-1
Cross beam adaptor



Item number: 5866500

T5-1
Flexible and adjustable cross beam adaptor



Item number: 5866700

T6-1
Innovative cross beam adaptor



Item number: 5866050

FW2-90
V-saddle



Item number: 9112700

FW2-130
V-saddle



Item number: 9112710

PIT JACK

ACCESSORIES GDT:

US-100
U-saddle



Item number: 9113210

US-130
U-saddle



Item number: 9113240

GR
Handle



Item number: 5863400

HSD-F
Front air connection kit



Item number: 5863410